

# Slim Digital Pressure Sensor

# E8CB/E8CC

CSM\_E8CB\_E8CC\_DS\_E\_2\_1

## E8CC with Built-in Microcomputer and Digital Display

- Withstands a pressure of 490 kPa and highly reliable.
- Incorporates a two-turn pressure adjuster ensuring easy pressure setting.

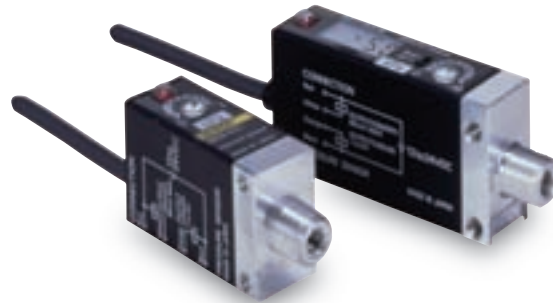

 Be sure to read *Safety Precautions* on page 5.

## Ordering Information

Digital display	Pressure range		ON/OFF output	Linear output	Model
No	Positive pressure	0 to 100 kPa	NPN open collector	1 to 5 V	E8CB-01C
	Negative pressure	0 to -100 kPa			E8CB-CN0C2B
Yes	Positive pressure	0 to 98 kPa			E8CC-A01C
	Negative pressure	0 to -101 kPa			E8CC-AN0C
	Positive pressure	0 to 980 kPa			E8CC-B10C

## Ratings and Specifications

Item	Model	E8CB-01C	E8CB-CN0C2B*	E8CC-A01C	E8CC-AN0C*	E8CC-B10C
Power supply voltage		12 to 24 VDC $\pm 10\%$ with a ripple (p-p) of 5% max.				
Current consumption		20 mA max.		30 mA max.		
Pressure type		Gauge pressure				
Permissible pressure range		0 to 100 kPa	0 to -100 kPa	0 to 98 kPa	0 to -101 kPa	0 to 980 kPa
Pressure setting range		0 to 100 kPa	0 to -100 kPa	0 to 98 kPa	0 to -101 kPa	0 to 980 kPa
Pressure indication unit		---		kPa		
Withstand pressure		490 kPa				1.5 MPa
Applicable material		Noncorrosive and nonflammable gases				
Repeat accuracy (ON/OFF output)		$\pm 1\%$ FS max.				
Accuracy (linear output)		$\pm 3\%$ FS max.				
Differential travel (ON/OFF output)		2% FS max.				
Linearity (linear output)		$\pm 1\%$ FS max.				
Response time		5 ms max.				
Linear output		1 to 5 V with an output impedance of 20 $\Omega$ and a permissible resistive load of 10 k $\Omega$ min.				
ON/OFF output		NPN open collector				
	Load current	80 mA max.				
	Output applied voltage	30 VDC max.				
	Residual voltage	1 V max. (with a load current of 80 mA) and 0.4 V max. (with a load current of 20 mA)				
Protection circuits		Reversed power supply connection and load short-circuiting				
Display (See note.)		Operation indicator (red)		2 <sup>1/2</sup> -digit LCD, operation indicator (red)		
Display accuracy		---		$\pm 3\%$ FS $\pm 1$ digit max. (within a temperature range between 0°C and 50°C) $\pm 4\%$ FS $\pm 1$ digit max. (within a temperature range between 50°C and 55°C) $\pm 5\%$ FS $\pm 1$ digit max. (within a temperature range between -10°C and 0°C)		
Ambient temperature		Operating: -10°C to 55°C (with no icing) Storage: -25°C to 70°C (with no icing)				
Ambient humidity		Operating/Storage: 35% to 95% (with no condensation)				
Temperature influence		$\pm 0.12\%$ FS/°C between 0°C and 50°C and $\pm 0.2\%$ FS/°C max. between -10°C and 0°C or 50°C and 55°C				
Voltage influence		$\pm 1.5\%$ FS max.				
Insulation resistance		50 M $\Omega$ min. (at 500 VDC) between current carrying parts and case				
Dielectric strength		1,000 VAC for 1 min				
Vibration resistance (destruction)		10 to 500 Hz, 1.5-mm double amplitude or 100 m/s <sup>2</sup> for 2 hours each in X, Y, and Z directions				
Shock resistance (destruction)		1,000 m/s <sup>2</sup> 3 times each in X, Y, and Z directions				
Degree of protection		IEC 60529 IP50				
Pressure inlet		R(PT)1/8, and M5 female screw				
Connection method		Pre-wired (Standard cable length: 2 m)				
Weight (packed state)		Approx. 70 g		Approx. 80 g		
Material	Pressure port	Aluminum				
Accessories		Instruction manual		Instruction manual, DIN track mounting bracket		

Note: An example of a 2<sup>1/2</sup>-digit display is shown below.

	Rated pressure range	Digital display		
		3rd digit	2nd digit	1st digit
Positive pressure	0 to 98 kPa		9	8
	0 to 980 kPa		9	8
Negative pressure	0 to -101 kPa	---	1	0

Note: The display values shown above are for when the maximum rated pressure is applied.

\* These models are negative-pressure models.

Engineering Data (Typical)

Linear Output Fluctuation vs. Temperature

E8CB-01C

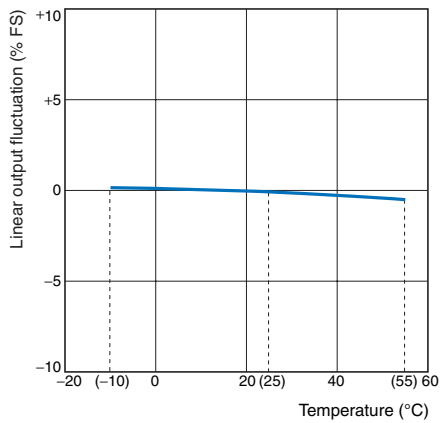

E8CC-A01C

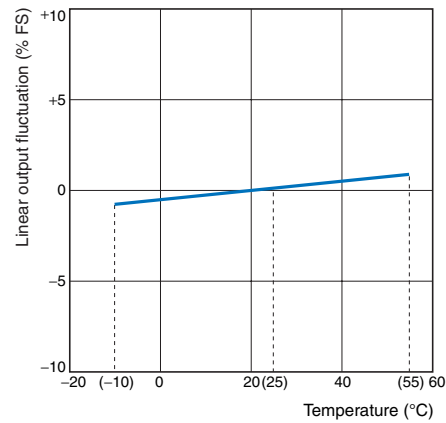

Linear Output Voltage vs. Pressure

E8CB-01C

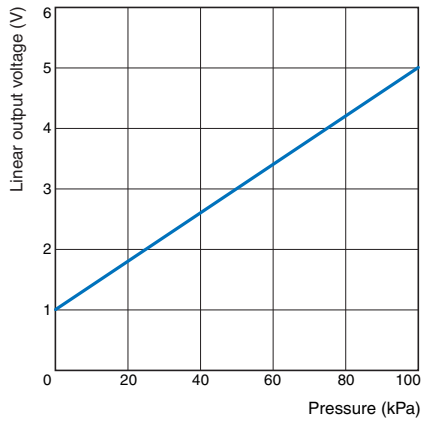

E8CC-A01C

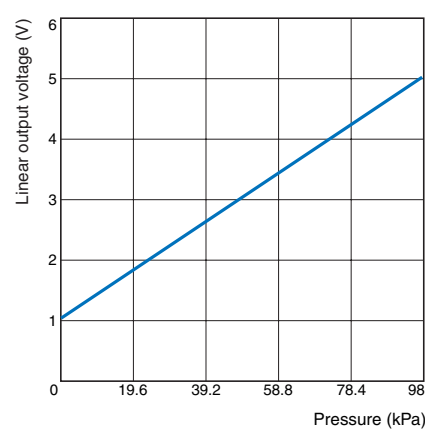

Operating Pressure vs. Temperature

E8CB-01C

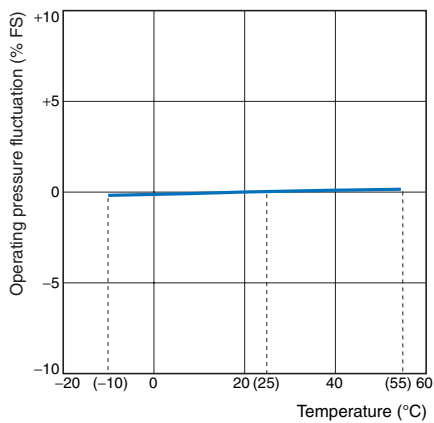

E8CC-A01C

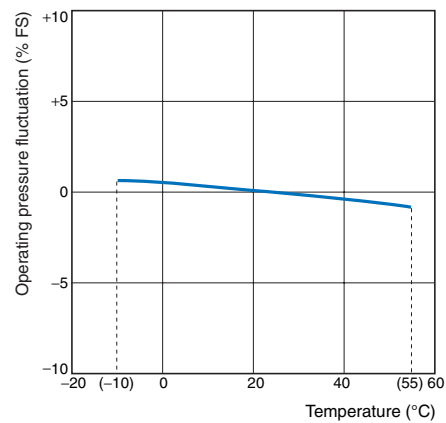

**Linearity**

**E8CB-01C**

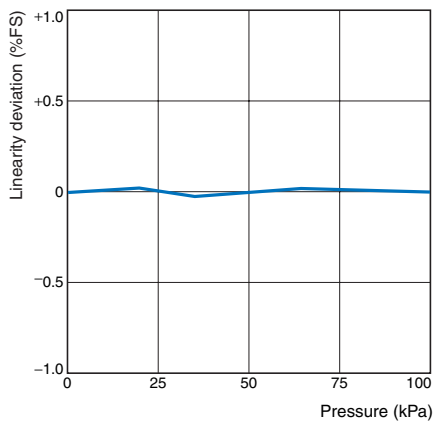

**E8CC-A01C**

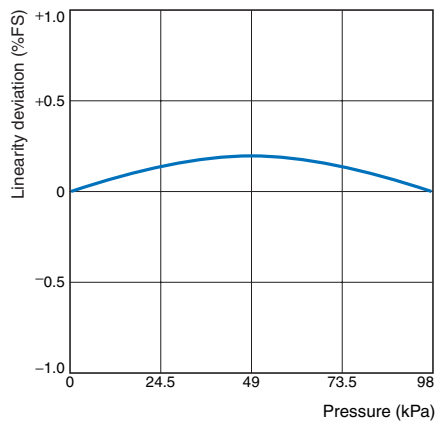

**Operating Pressure Fluctuation vs. Voltage**

**E8CB-01C**

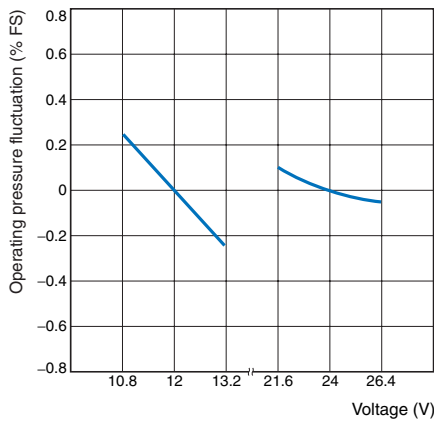

**E8CC-AN0C**

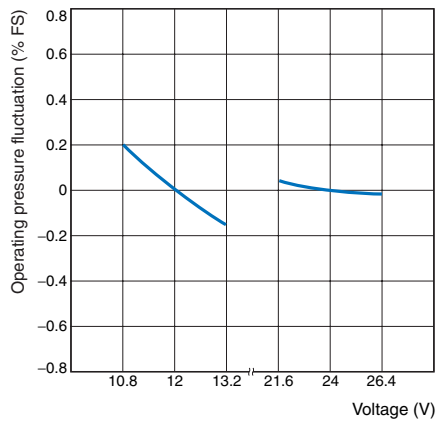

**Linear Output Fluctuation vs. Voltage**

**E8CB-01C**

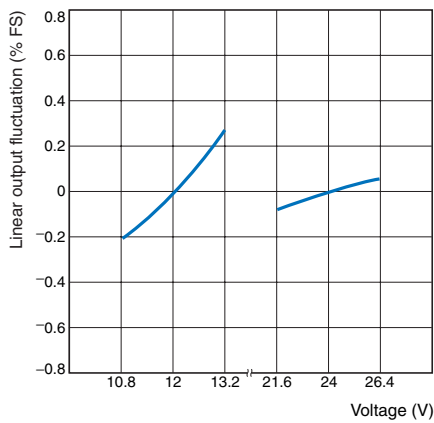

**E8CC-AN0C**

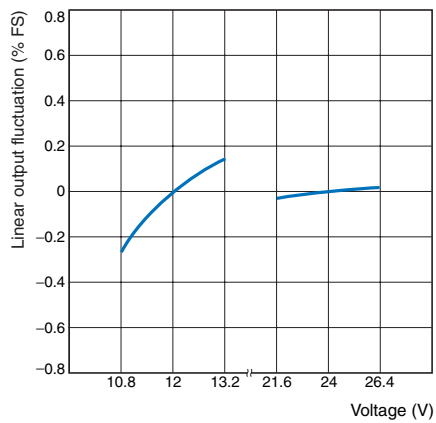

## I/O Circuit Diagrams

### NPN Output

Model	Timing Charts	Output Circuits
E8CB-01C E8CC-A01C E8CC-B10C		
E8CB-CN0C2B E8CC-AN0C		

## Safety Precautions

### WARNING

This product is not designed or rated for ensuring safety of persons. Do not use it for such purposes.



### Precautions for Correct Use

Do not use the product in atmospheres or environments that exceed product ratings.

#### ● Mounting

##### Diaphragm

- If the diaphragm is damaged, the Pressure Sensor will not operate properly. Do not insert a screwdriver or steel wire into the interior of the pressure-sensitive parts through the pressure inlet.

##### Mounting

- The pressure inlet has an R (PT)1/8 taper screw and an M5 female screw. Apply sealing tape around a screw that conforms to JIS Standards so that no pressure leakage will occur.
- Do not apply a tightening torque higher than 3.9 N·m.
- If the Pressure Sensor is directly connected to a conduit, be sure to apply a wrench to the pressure inlet. Do not apply the wrench to the plastic case.

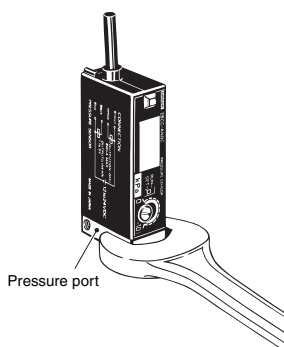

### DIN Track Mounting Bracket (E8CC)

#### ● Mounting

1. Fit the front part onto the bracket.
2. Press the rear part onto the bracket.

#### ● Removing

3. Apply a flat-blade screwdriver to the rear hook. Then the Pressure Sensor can be removed with ease.

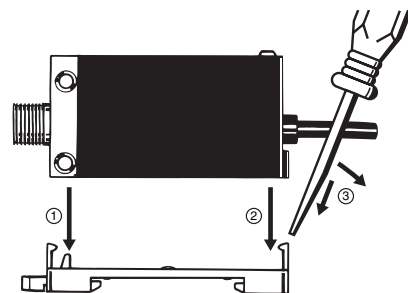

DIN track mounting bracket

#### ● Wiring

- If no linear output is used, cut off the black lead wire and apply insulation tape to the lead wire so that it will not come in contact with any other terminal.

## ● Adjustment

### Setting the Pressure on the E8CC

1. Set the mode selector to SET.



2. Turn the pressure adjuster to the desired pressure.

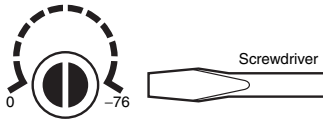

3. Set the mode selector to RUN.



The E8CC has, however, normal output in SET mode. Change in pressure setting is possible in RUN mode by turning the pressure adjuster. Do not turn the pressure adjuster after the pressure adjuster has been set to the desired pressure.

### Indications

Display	Mode	Operating status	Description	Permissible range		
				Positive pressure		Negative pressure
				E8CC -A01C	E8CC -B10C	E8CC -AN0C
30 (for 30 kPa)	RUN	Normal	Displays the imposed pressure within the permissible range.	0 to 98 kPa	0 to 980 kPa	0 to -101 kPa
	SET	Normal	Displays the ON-point setting pressure within the permissible range			
--	RUN	Abnormal pressure imposition	<ul style="list-style-type: none"> <li>Positive Pressure: Indicates that the imposed pressure is lower than the permissible range.</li> <li>Negative Pressure: Indicates that the imposed pressure is higher than the permissible range. The E8CC is, however, in normal output operation in both cases.</li> </ul>	0 to 98 kPa	0 to 980 kPa	0 to -101 kPa
	SET	Abnormal pressure setting	<ul style="list-style-type: none"> <li>Positive Pressure: Indicates that ON-point setting pressure value is lower than the permissible range.</li> <li>Negative Pressure: Indicates that ON-point setting pressure is higher than the permissible range. The E8CC is, however, in normal output operation in both cases.</li> </ul>			
FF	RUN	Abnormal pressure imposition	Indicates that the imposed pressure is higher than the permissible range.	0 to 98 kPa	0 to 980 kPa	---
	SET	Abnormal pressure setting	<ul style="list-style-type: none"> <li>Positive Pressure: Indicates that ON-point setting pressure value is higher than the permissible range.</li> <li>Negative Pressure: Indicates that ON-point setting pressure is lower than the permissible range. The E8CC is, however, in normal output operation in both cases.</li> </ul>			0 to -101 kPa
LE	RUN	Load over-current	Indicates that the output transistor has excessive load current, in which case, the output of the E8CC is turned OFF and this display flashes until the condition returns to normal. Check the output wiring if this display flashes.	0 to 98 kPa	0 to 980 kPa	0 to -101 kPa
	SET					
SH	RUN	Element destruction	Indicates that the Pressure Sensor element is damaged due to the imposition of excessive pressure or other reasons, in which case, the output of the E8CC is turned OFF. If this display appears, the E8CC can no longer be used.	0 to 98 kPa	0 to 980 kPa	0 to -101 kPa
	SET					

## Dimensions

### E8CB

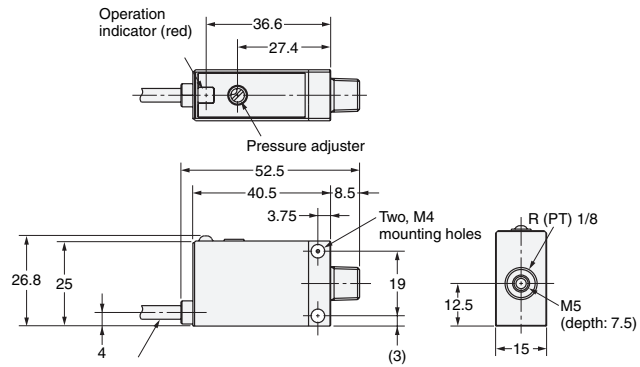
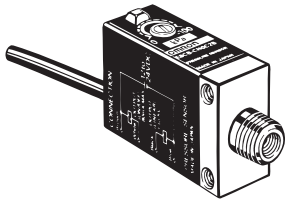

4-dia. vinyl-insulated round cable with 4 conductor,  
(Conductor cross-section: 0.2 mm<sup>2</sup>, Insulator diameter: 1.1 mm);  
Standard length: 2 m

### E8CC

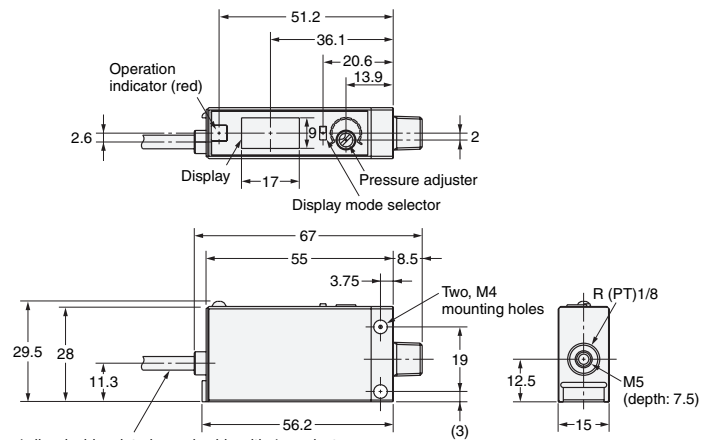
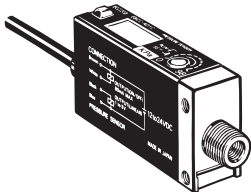

4-dia. vinyl-insulated round cable with 4 conductors,  
(Conductor cross-section: 0.2 mm<sup>2</sup>, Insulator diameter: 1.1 mm); Standard length: 2 m

### Mounted to a DIN Track Mounting Bracket

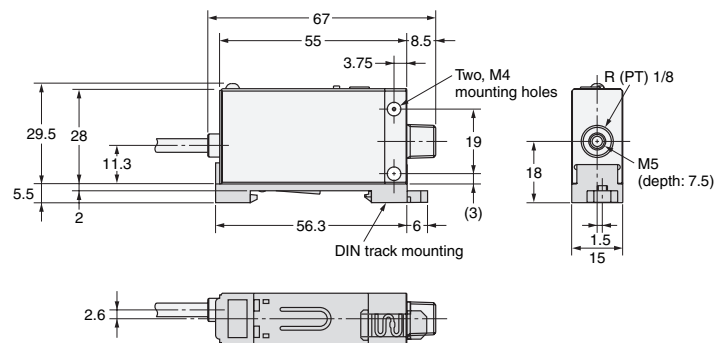
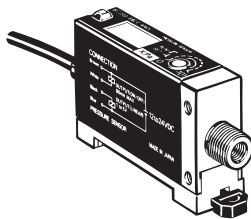

In the interest of product improvement, specifications are subject to change without notice.